

# Metal ButtonΦ16

## YJ-GQ16B Series Metal Button

### GENERAL

1. Installation dimensions: Φ16mm.
2. Head shape: flat round、high round.
3. Wiring mode: pin terminal.
4. Operation: momentary/maintained.
5. Contact: 1NO1NC/2NO2NC.
6. IP Degree: IP65(1NO1NC);IP40(2NO2NC).
7. The material of Keypad: stainless steel.
8. The material of shell: chrome plating of brass、stainless steel、aluminum alloy plating.
9. The material of base: PA66.

### LAMP SPECIFICATIONS

Lamp type	Two-way LED lamp	
Rated voltage	AC/DC 3V	AC/DC 6V
	AC/DC 12V	AC/DC 24V
	AC/DC 36V	AC/DC 48V
	AC/DC 110V	AC/DC 220V
Lamp color	R ● G ● Y ● B ● W ○	
Life	≥40000h	

### SWITCH RATING

Rated voltage(Ue)		12V	24V	110V	220V	
Rated current (Ie)	AC-15 50/60Hz	Resistive load	5A	5A	5A	3A
		Inductive load	5A	5A	3A	2A
	DC-13	Resistive load	1A	1A	0.2A	0.1A
		Inductive load	0.5A	0.5A	0.2A	0.1A

### CONTACT DESCRIPTION

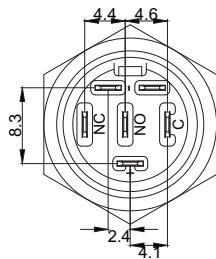

1NO1NC, Terminal(2.8×0.5)

### SPECIFICATION

Operating temperature	-25°C~ +55°C (Ice free)
Operating humidity	45-85%RH
Contact resistance	≤50mΩ
Insulation resistance	≥1000MΩ
Dielectric strength	1500VAC/50Hz/60s
Vibration resistance	50Hz, Amplitude 1.2mm
Shock resistance	> 10g
Solder heat resistance	when 320°C(or 30W electric iron), no more than 3 seconds
Switch rating	250V/5A
Mechanical life	≥1,000,000times
Electrical life	≥100,000times
Nut torque	about 0.6Nm
Operation stroke	about 2mm
Operating pressure	about 3N

### CONTACT DESCRIPTION

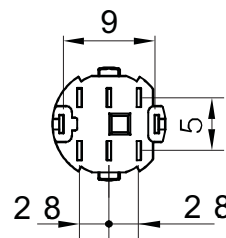
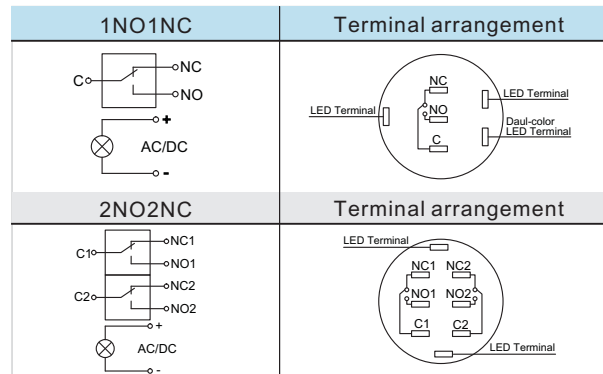

2NO2NC, Terminal(1.8×0.4)

### IMPLICATION OF TYPE









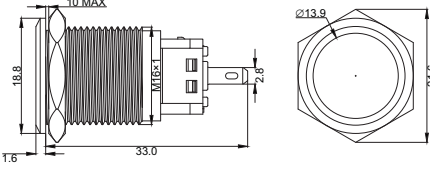

YJ-GQ16□	★	-⊙	▲/	☆	△	○
Code of series□: B : 1NO1NC type No letters: 2NO2NC type	Head shape: F : flat round H: high round	Contact: 11 : 1NO1NC 22 : 2NO2NC	Operation: No letters : momentary Z:maintained E:momentary with ring lamp EZ:maintained with ring lamp EP:momentary with ring lamp and luminous power logo EZP:maintained with ring lamp and luminous power logo DP:momentary with luminous power logo DZP:maintained with luminous power logo	Shell material: N:chrome plating of brass S:stainless steel A:aluminum alloy plating	Lamp voltage: 3V 6V 12V 24V 36V 48V 110V 220V	Color : ● R ● G ● Y ● B ○ W

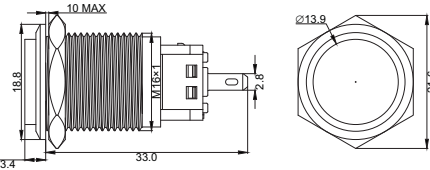
Note: the above table is only for model explanation, and some model combinations have no actual products. See the following figure for specific products.

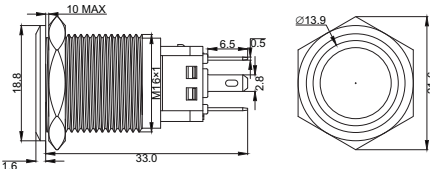
# Metal Button $\Phi 16$

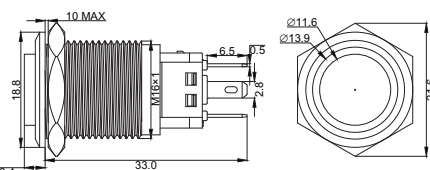
## YJ-GQ16B Series Metal Button

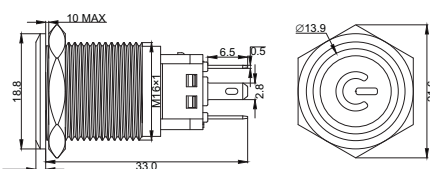
### PRODUCT SELECTION

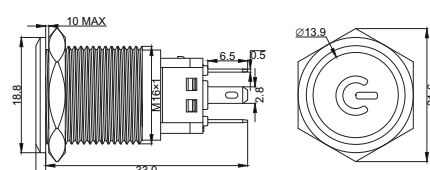
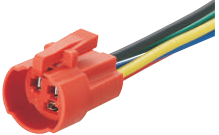
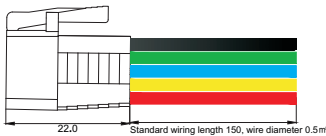
Picture	Operation	Model	Shape Dimensions
	Flat, momentary	YJ-GQ16BF-11/☆	
	Flat, maintained	YJ-GQ16BF-11Z/☆	
	High, momentary	YJ-GQ16BH-11/☆	
	High, maintained	YJ-GQ16BH-11Z/☆	
	Flat, momentary ring lamp	YJ-GQ16BF-11E/☆△○	
	Flat, maintained ring lamp	YJ-GQ16BF-11EZ/☆△○	
	High, momentary ring lamp	YJ-GQ16BH-11E/☆△○	
	High, maintained ring lamp	YJ-GQ16BH-11EZ/☆△○	
	Flat, momentary ring lamp with luminous power logo	YJ-GQ16BF-11EP/☆△○	
	Flat, maintained ring lamp with luminous power logo	YJ-GQ16BF-11EZP/☆△○	
	Flat, momentary luminous power logo	YJ-GQ16BF-11DP/☆△○	
	Flat, maintained luminous power logo	YJ-GQ16BF-11DZP/☆△○	
	Matching no light button: 3 lines	Matching no light button: 3 lines  Matching illuminated button: 5 lines	 Standard wiring length 150, wire diameter 0.5mm Note: the red and black lines are LED lines, the green line is the common terminal (C), the blue line is NO, and the yellow line is NC. You can consult the customized line length.
	Matching illuminated button: 5 lines		





### COMBINATION DIAGRAM OF BUTTON AND SOCKET

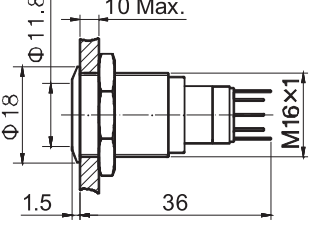

# Metal Button $\Phi 16$

## YJ-GQ16B Series Metal Button

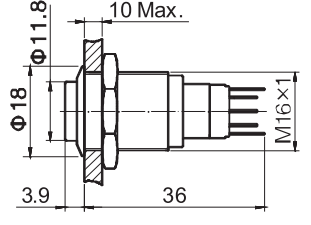
### PRODUCT SELECTION

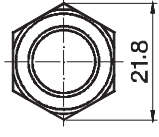
Picture	Operation	Model	Shape Dimensions		
	Flat, momentary	YJ-GQ16F-22/☆	 <p>Flat</p>		
	Flat, maintained	YJ-GQ16F-22Z/☆			
	High, momentary	YJ-GQ16H-22/☆			
	High, maintained	YJ-GQ16H-22Z/☆			
	Flat, momentary ring lamp	YJ-GQ16F-22E/☆△○		 <p>High</p>	
	Flat, maintained ring lamp	YJ-GQ16F-22EZ/☆△○			
	High, momentary ring lamp	YJ-GQ16H-22E/☆△○			
	High, maintained ring lamp	YJ-GQ16H-22EZ/☆△○			
	Flat, momentary luminous power logo	YJ-GQ16F-22DP/☆△○			
	Flat, maintained luminous power logo	YJ-GQ16F-22DZP/☆△○			